

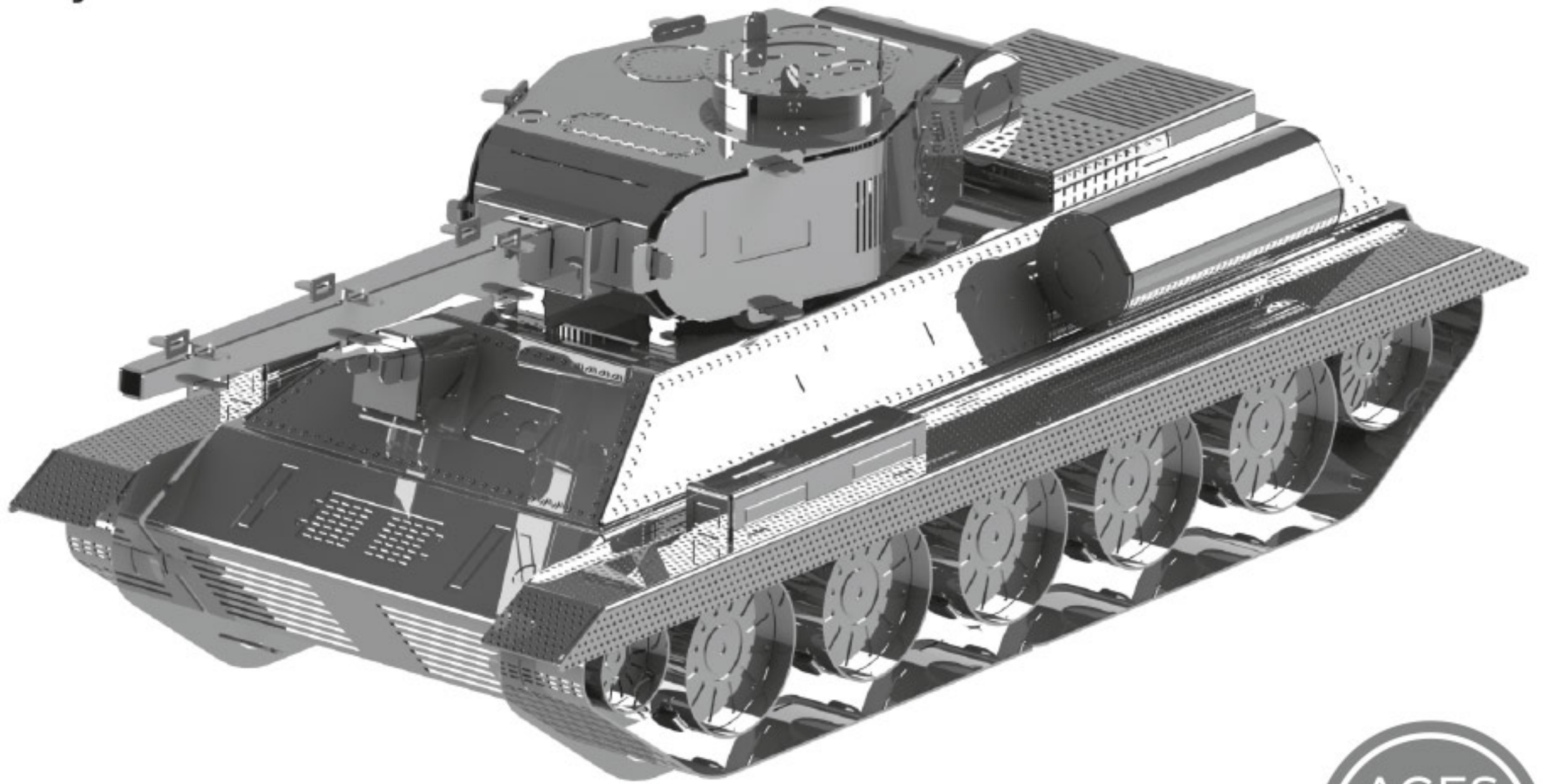

METAL[®]
TIME

T-34-85

3D Metal Model Building Kit
Assembly instructions



Collect the Best

61 PIECES

1 hours

AGES
14+



MODEL PARTS AND ASSEMBLY TOOLS

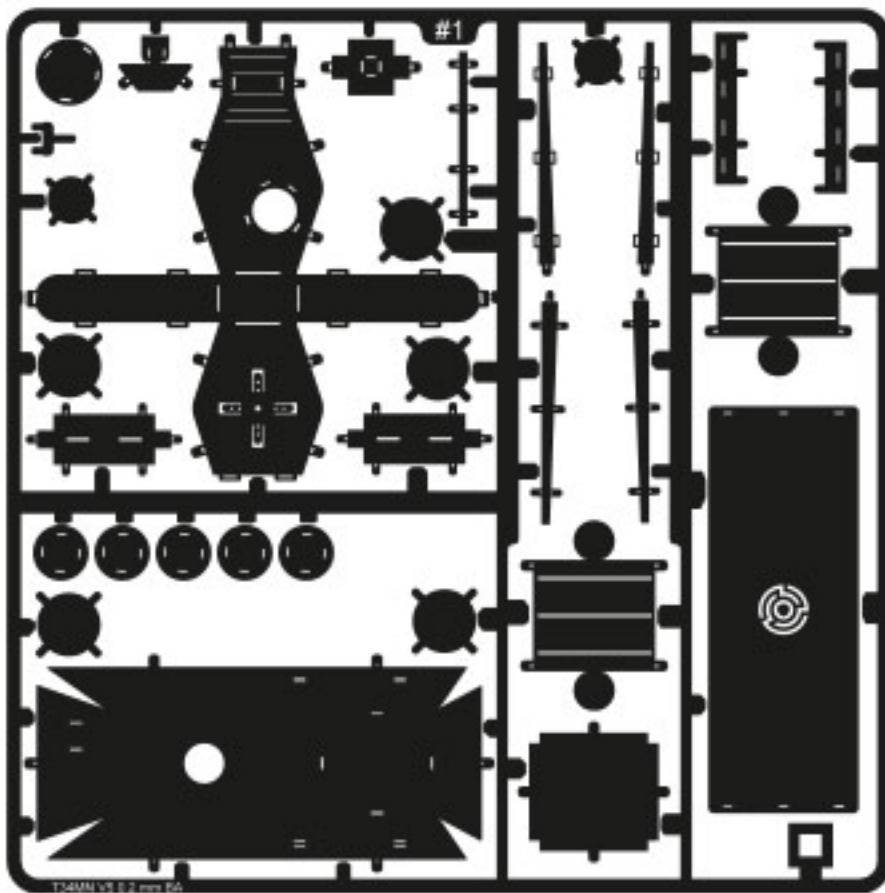

#1

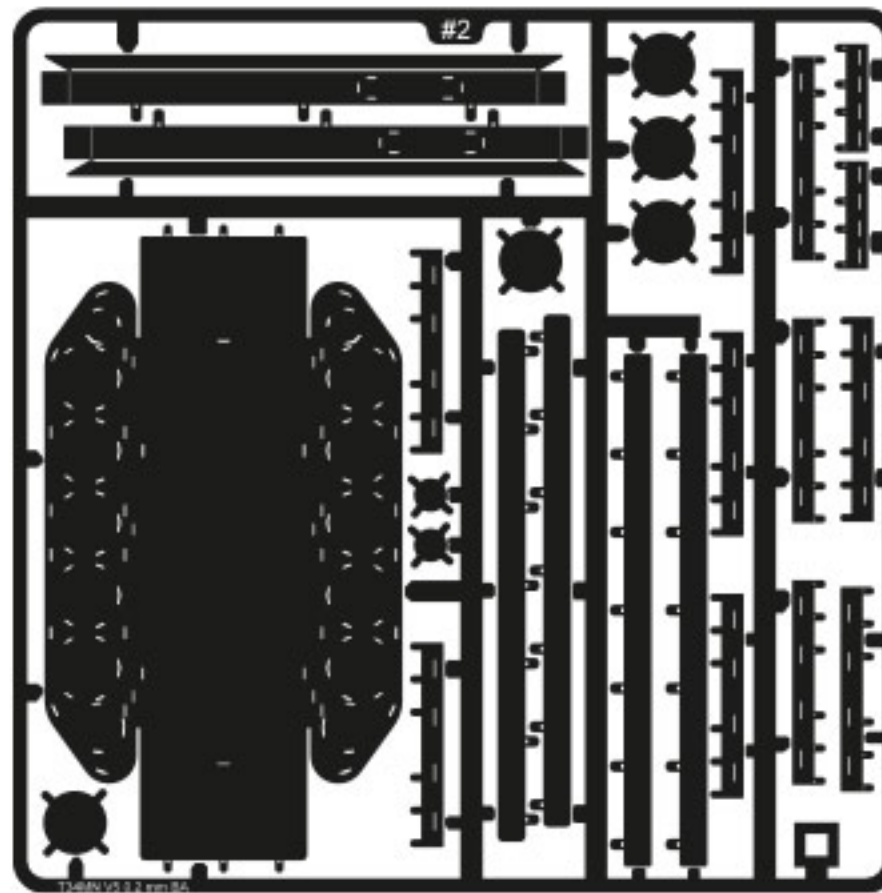

#2

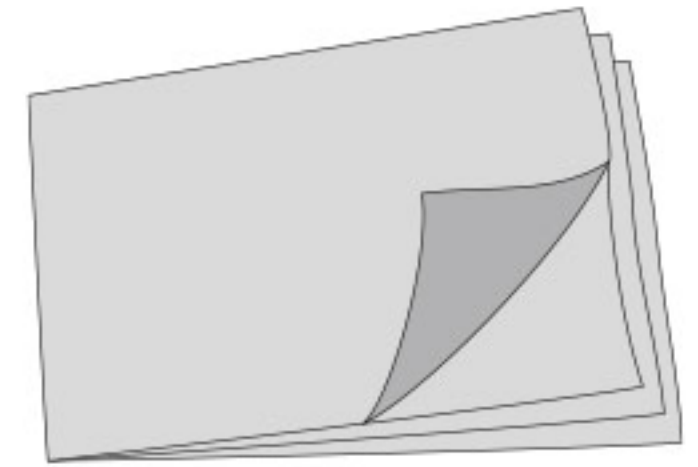

Polishing cloth

STANDARD FIXING OF FASTENERS

When assembling the model, don't rush, avoid pointing details at yours or anyone else's face. If one of the parts has a sharp edge, please file it down. Use pliers and additional tools to assemble the model. Each kit contains a cloth for wiping and polishing the model once it's assembled.

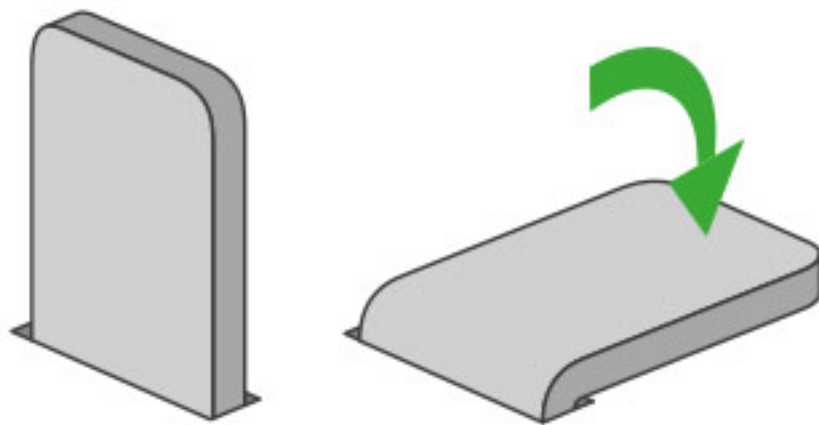

If there are no additional designations, use the standard fixing method

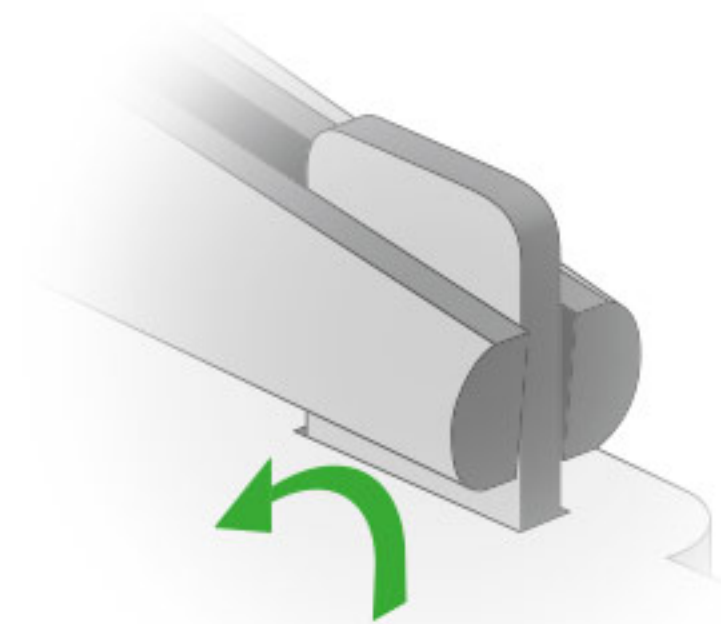

Use pliers to bend the fasteners

WARNING! Product contains small parts and sharp parts. Not suitable for children under 3 years of age. Model for collectors, suitable for children 14+

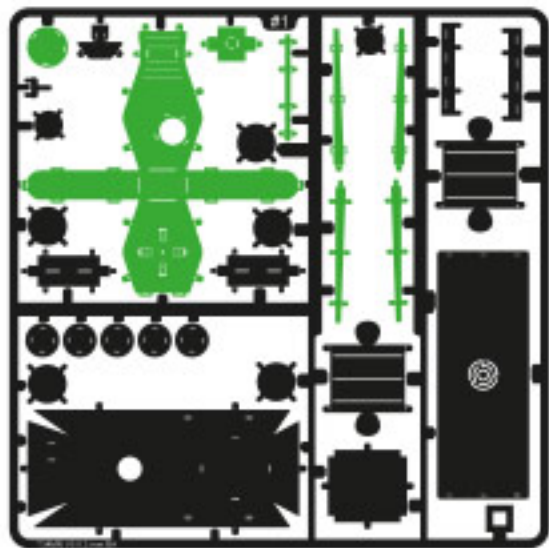

#1

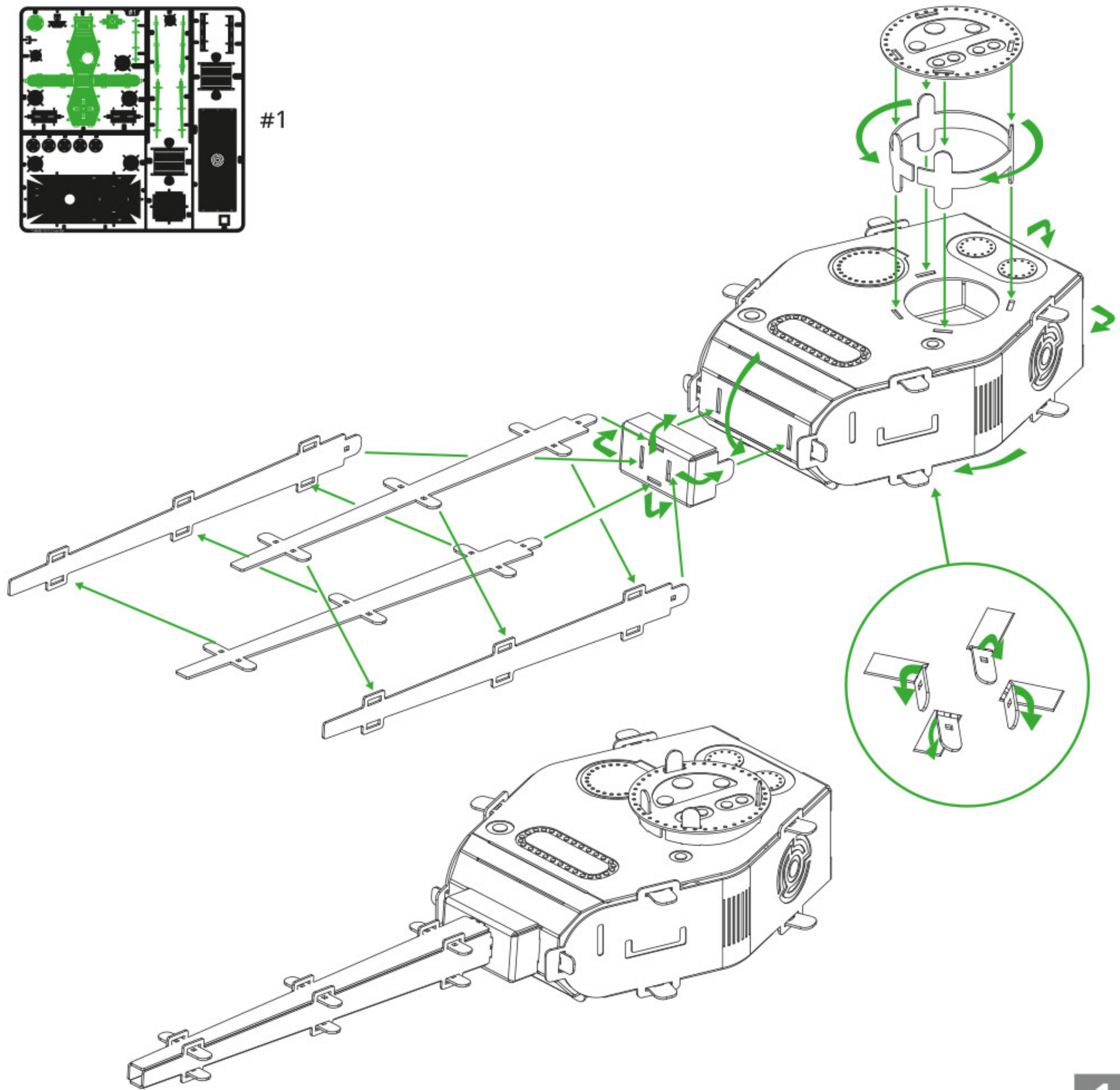

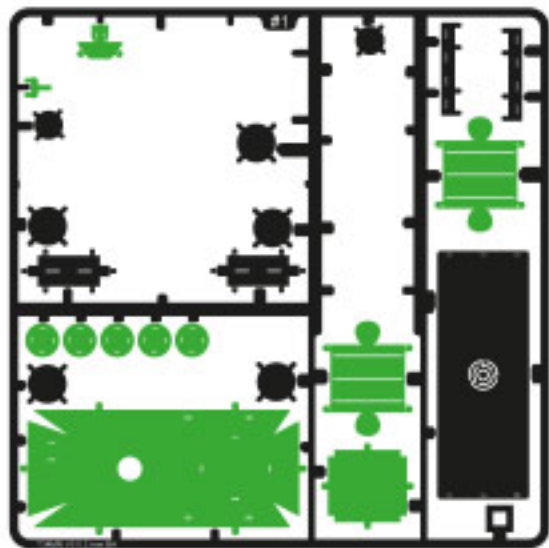

#1

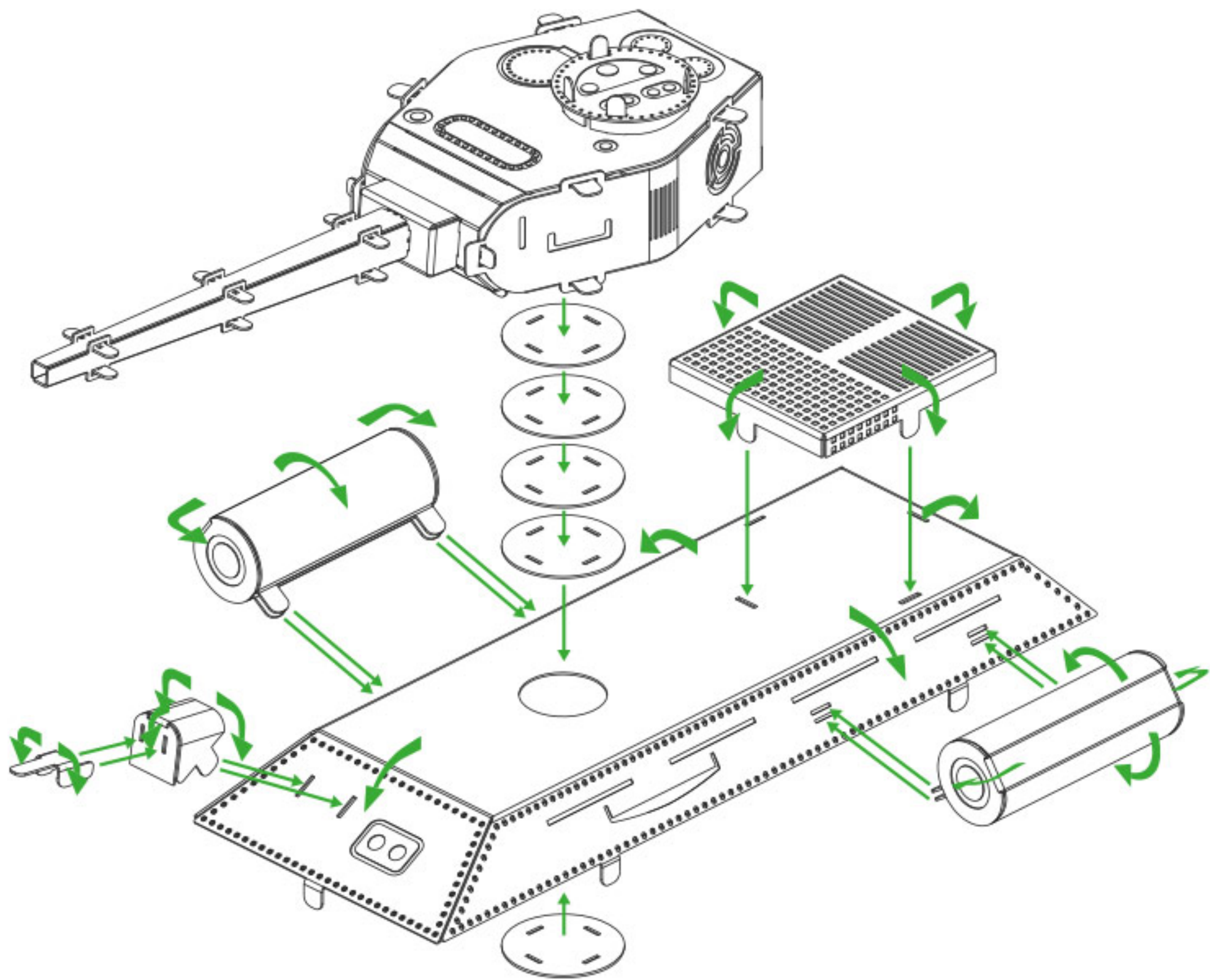
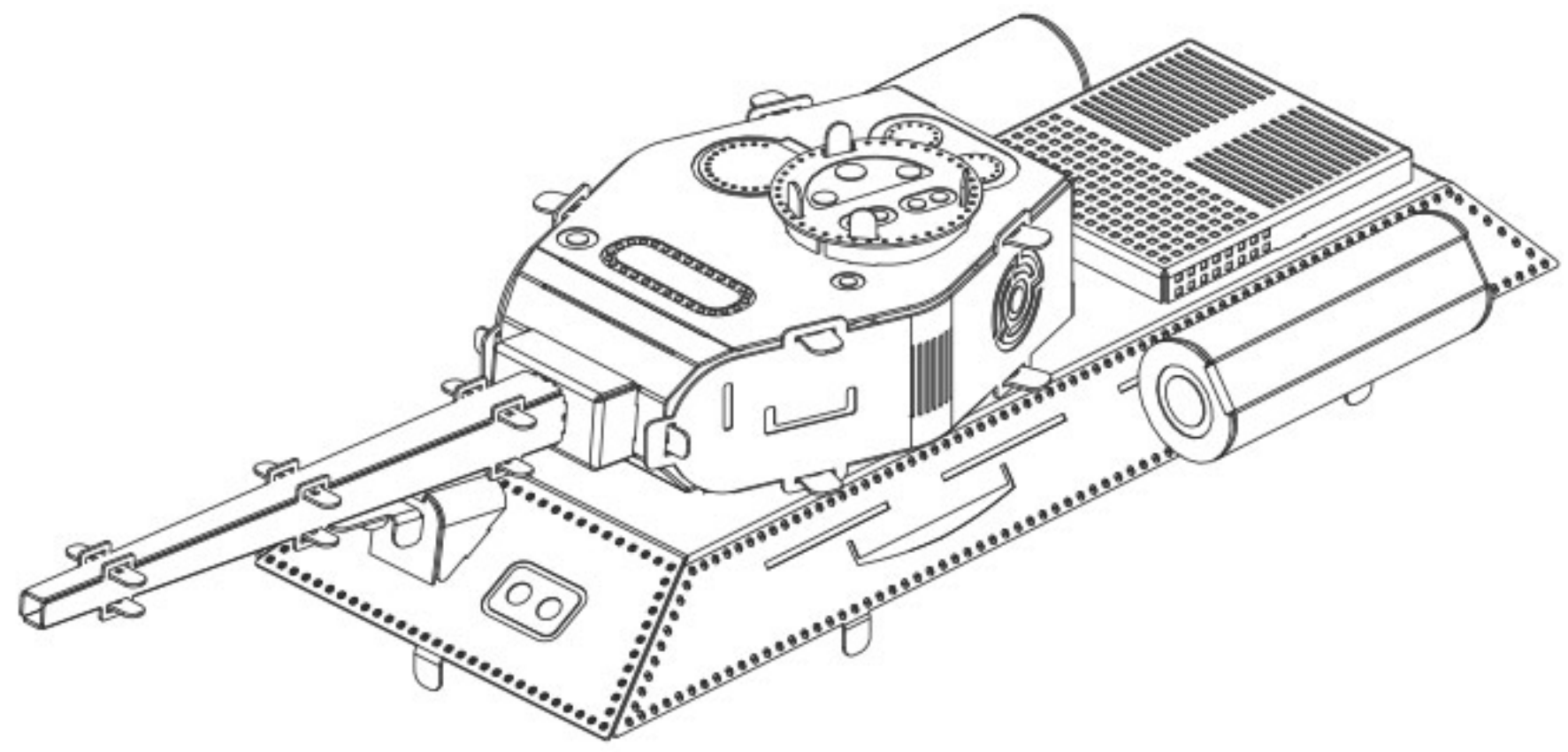

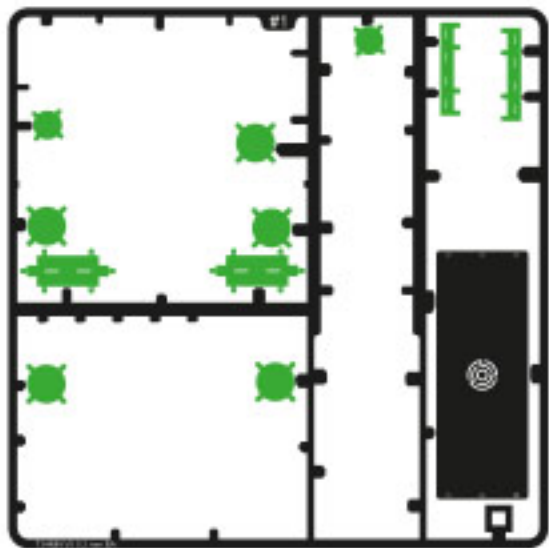

#1

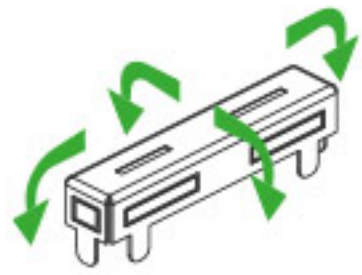

x2

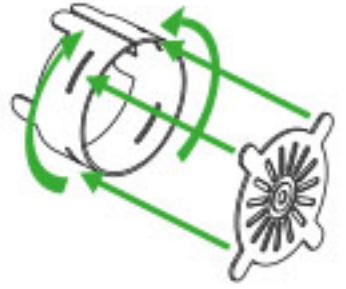

x2



x2

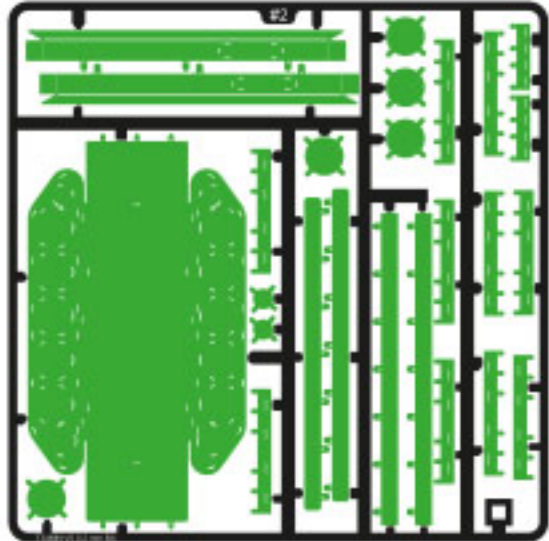

#2

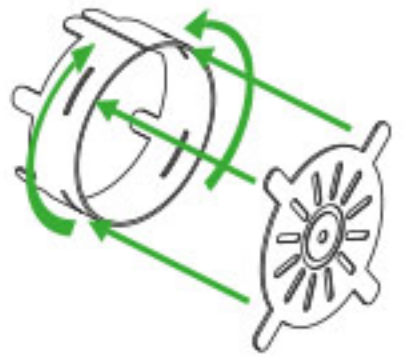

x10

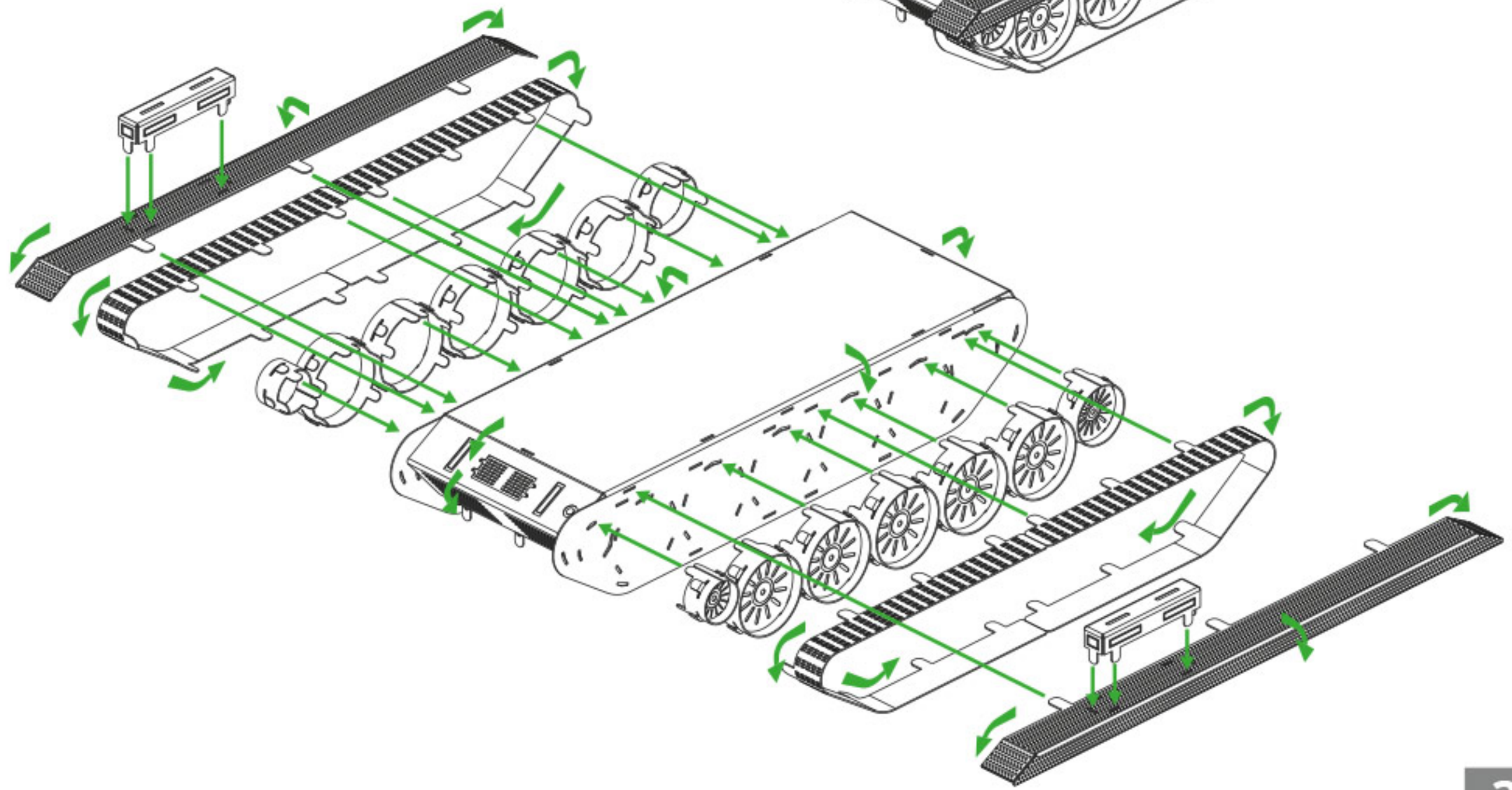
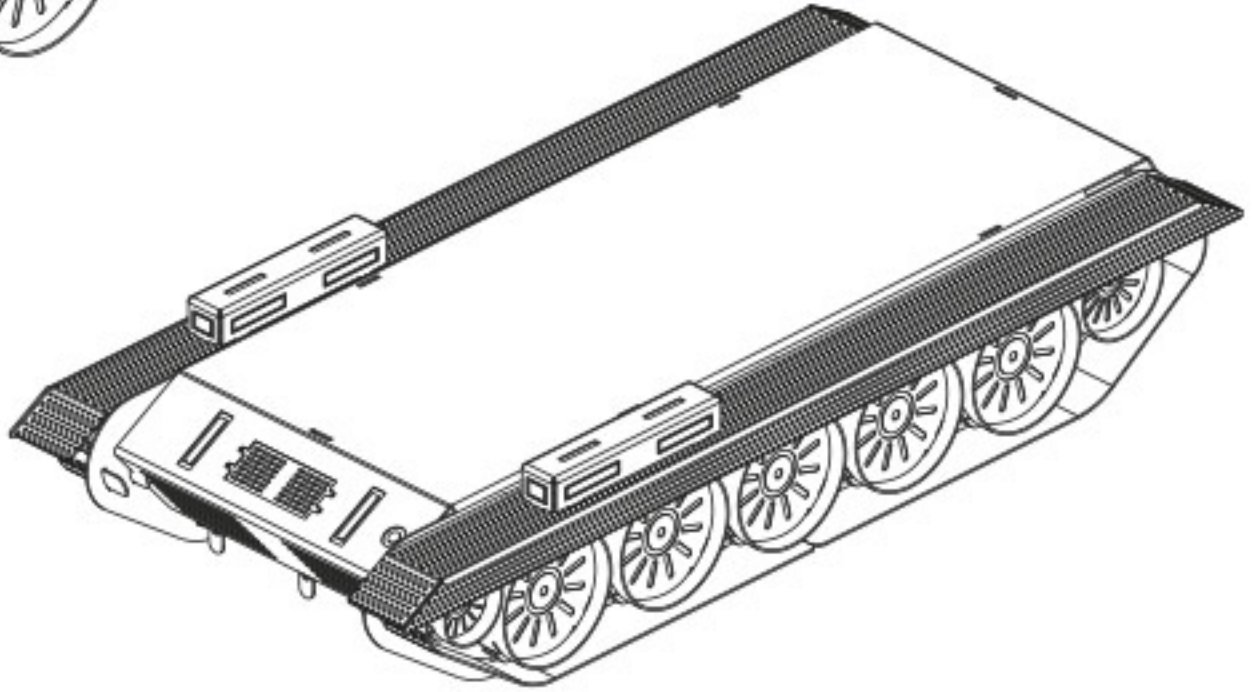

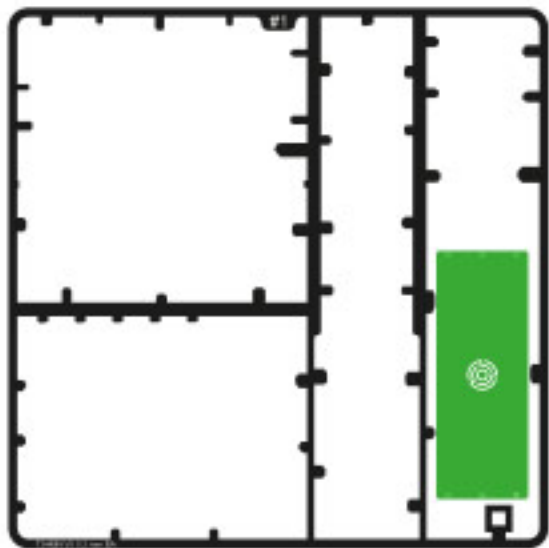

#1

